

4" SQUARE (4S) DEEP BOXES

WELDED
2-1/8" DEEP

30.3 Cu. In.

WITH NON-METALLIC (NM) SHEATHED CABLE CLAMPS

NOTE

- ▶ For Fixture/Luminaire Support of 50 lbs or less

Cat. No.	Bracket & Setback	Knockouts		Std. Pkg.
		Sides	Bottom	
4SDB-NM	-	4 - 1/2", 2 - MKO, 4 - Loom	1 - 1/2"	24
*4SDB-NM-B	B, Flush	2 - 1/2", 1 - MKO, 4 - Loom	1 - 1/2"	24
4SDB-NM-FB	FB, Flush	2 - 1/2", 1 - MKO, 4 - Loom	1 - 1/2"	24
*4SDB-NM-WB	WB, Flush	2 - 1/2", 1 - MKO, 4 - Loom	1 - 1/2"	24

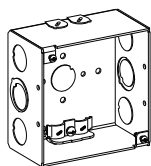

4SDB-NM

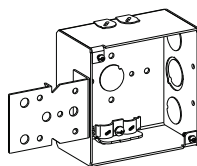

*4SDB-NM-B

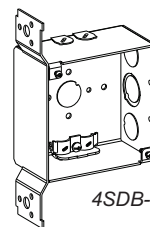

4SDB-NM-FB

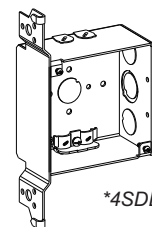

*4SDB-NM-WB

4" SQUARE (4S) EXTRA DEEP BOXES

WELDED
3-1/2" DEEP

46.0 Cu. In.

PRODUCT FEATURES

- ▶ Durable Red Powder Coat Finish for FA Series
- ▶ UMAB & UMIAB's mount direct-to-stud or used with the SSB-T5 or SSB-TBAR for between stud or ceiling installation (see pg. P1 for more info.)
- ▶ UMAB's depth adjusted via screws outside of the box
- ▶ UMIAB's depth adjusted via screws inside the box

NOTE

- ▶ For Fixture/Luminaire Support of 50 lbs or less (except UMAB's & UMIAB's)

Cat. No.	Bracket & Setback	Knockouts		Std. Pkg.
		Sides	Bottom	
4SEDB-CKO	-	12 - CKO	4 - CKO	24
FA-4SEDB-CKO	-	12 - CKO	4 - CKO	24
*4SEDB-CKO-FB	FB, 1/2" thru 1-1/4"	10 - CKO	4 - CKO	10
*FA-4SEDB-CKO-FB	FB, 1/2" thru 1-1/4"	10 - CKO	4 - CKO	10
UMAB	Stud-mount, adjustable 0" to 1-1/2"	12 - CKO	4 - CKO	10
FA-UMAB	Stud-mount, adjustable 0" to 1-1/2"	12 - CKO	4 - CKO	10
UMIAB-35 NEW	Stud-mount, adjustable 1/2" to 1-1/2"	12 - CKO	4 - CKO	10
FA-UMIAB-35 NEW	Stud-mount, adjustable 1/2" to 1-1/2"	12 - CKO	4 - CKO	10

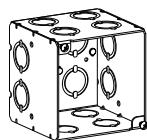

4SEDB-CKO

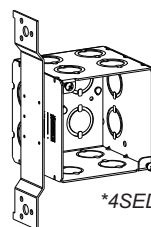

*4SEDB-CKO-FB

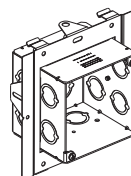

UMAB



UMIAB-35



FA-4SEDB-CKO



*FA-4SEDB-CKO-FB



FA-UMAB



FA-UMIAB-35

- ▶ **600V** MKO's and CKO's suitable for bonding without any additional bonding means up to 600V
- ▶ Acceptable for use in 2-hour rated walls
- ▶ Visit www.ul.com or QCIT Guide on page W1 for more information



FIRE ALARM BOXES & COVERS

PRODUCT FEATURES

- ▶ Provide easy identification of products containing cabling of Fire Alarm Systems
- ▶ Prevent need for repainting
- ▶ Industrial, Commercial or Residential Use
- ▶ Durable Red Powder Coat Finish

NOTE

- ▶ Additional specs located with corresponding models without red finish in catalog
- ▶ All 4S Boxes are certified for Fixture/Luminaire Support of 50 lbs or less (except for UMAB & UMIAB)
- ▶ **600V** MKO's and CKO's suitable for bonding without any additional bonding means up to 600V
- ▶ Acceptable for use in 2-hour rated walls (4S Box only)
- ▶ Visit www.ul.com or QCIT Guide on page W1 for more information

Cat. No.	Description	Knockouts		Std. Pkg.
		Sides	Bottom	
*FA-4RBC	Red 4" Octagon Blank Cover	-	-	50
FA-4BC	Red 4" Square Blank Cover	-	-	50
FA-4SB-MKO	Red 4" Square, 1-1/2" Deep Box	8 - 1/2", 4 - MKO	2 - 1/2", 2 - MKO	50
FA-4SB-MKO-EXT	Red 4" Square, 1-1/2" Deep Extension	8 - 1/2", 4 - MKO	-	50
FA-4SDB-75	Red 4" Square, 2-1/8" Deep Box	8 - 3/4"	2 - 1/2", 2 - MKO	24
FA-4SDB-MKO	Red 4" Square, 2-1/8" Deep Box	8 - 1/2", 4 - MKO	2 - 1/2", 2 - MKO	24
FA-4SDB-MKO-FB	Red 4" Square, 2-1/8" Deep Box w/ FB Bracket	6 - 1/2", 3 - MKO	3 - 1/2", 2 - MKO	24
FA-4SEDB-CKO	Red 4" Square, 3-1/2" Deep Box	12 - CKO	4 - CKO	24
*FA-4SEDB-CKO-FB	Red 4" Square, 3-1/2" Deep Box w/ FB Bracket	10 - CKO	4 - CKO	10
FA-UMAB	External Adjustment Red 4" Square, 3-1/2" Deep Box, 46 Cu. In., Adj. range: 0" to 1-1/2"	12 - CKO	4 - CKO	10
FA-UMIAB-35 NEW	Internal Adjustment Red 4" Square, 3-1/2" Deep Box, 46 Cu. In., Adj. range: 1/2" to 1-1/2"	12 - CKO	4 - CKO	10
FA-UMAB-4R	External Adjustment Red 4" (40), 2-1/8" Deep Box, 21.1 Cu. In., Adj. range: 0" to 1-1/2"	2 - 1/2", 2 - MKO	3 - 1/2", 2 - 3/4"	20
FA-5BC	Red 4-11/16" Square Blank Cover	-	-	50
FA-5SDB-MKO	Red 4-11/16" Square, 2-1/8" Deep Box	2 - 1/2", 10 - MKO	2 - 1/2", 2 - 3/4"	24



*FA-4RBC



FA-4BC



FA-4SB-MKO



FA-4SB-MKO-EXT



FA-4SDB-75



FA-4SDB-MKO



FA-4SDB-MKO-FB



FA-4SEDB-CKO



*FA-4SEDB-CKO-FB



FA-UMAB



FA-UMIAB-35



FA-UMAB-4R



FA-5BC



FA-5SDB-MKO

UNIVERSAL CUT-IN BOX ADAPTER

PRODUCT FEATURES

- ▶ Quickly mount any 4" square steel junction box into old work applications
- ▶ Works with 4" square boxes of any depth
- ▶ Two integrated old work steel clips with screws
- ▶ For drywall or other wall materials
- ▶ Small footprint easily concealed by life safety devices greater than 4-7/8" W X 4-3/4" H
- ▶ Available in Red powder coat finish for FA circuits

Visit our website to download a wall mounting template

Cat. No.	Description	Std. Pkg.
UCIA-4S NEW	Cut-in adapter for 4" Square Boxes	20
FA-UCIA-4S NEW	Red Cut-in adapter for 4" Square Boxes	20

Turn any 4" square box into an "Old Work" box!



UCIA-4S



FA-UCIA-4S



FIRE ALARM



PREFABRICATION

Small footprint easily concealed by life safety devices Prepare 4" boxes with UCIA-4S in the shop

BOX & ADAPTER LATCHES

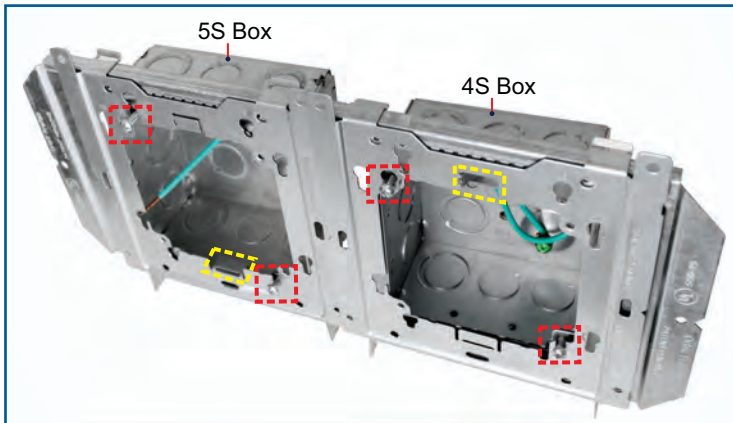

BOX TO ADAPTER LATCH

Bendable latch tabs securely hold 4" or 4-11/16" sq. box in place without need to tighten box screws. Skip hassle of tightening box screws until the final ring installation, making installation process more efficient and convenient.

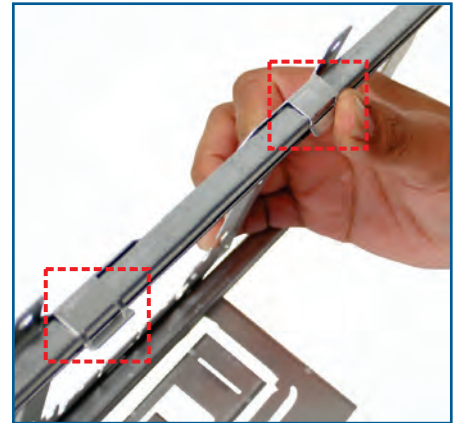

ADAPTER TO BRACKET LATCH

Fold tab to secure adapter on SSB Brackets

90° ROTATION



Extended Mounting Tab enables secure mounting with 90° rotation. Box will be able to receive large conduit without removal of back support.

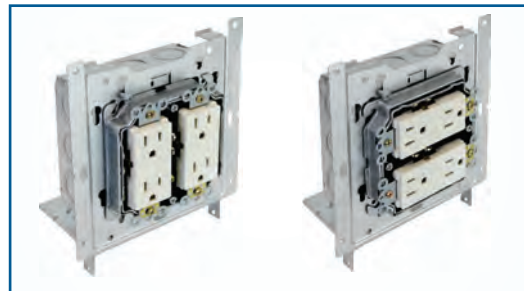

All *AR1G- & *AR2G- rings install vertical or horizontal

STUD MOUNT

SIMPLE SUPPORT BRACKET

PRODUCT FEATURES

- Adjusts from 15" to 25", rigidity eliminates need for farside back support
- Accepts 4", 4-11/16" & 5" Sq. Boxes; must be paired with UMA-LVBS to mount 5" Sq. Boxes
- Expand without removing adapters or junction boxes (ideal for prefabrication)
- Install between wall studs or overhead between hard lid ceiling joists
- Must be accompanied with either UMA or UMA-LVBS to mount a junction box. UMAB's/UMIAB's also snap on
- See pg. P1 for complete SSB Family of products



Fits 5" square boxes!

VERTICAL & HORIZONTAL RING INSTALLATION

UMA: 4" & 4-11/16" sq. box adapter compatible with all Adjustable Rings

Mounting hole and center cutout for a quick, leveled installation

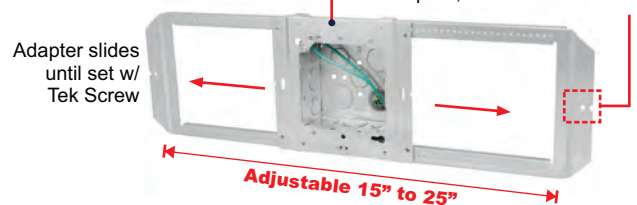

Order preassembled with box and 10" pigtail as SSB-4S-MKO, SSB-A4, SSB-5S-MKO or SSB-T5B-200 (pg. P5-6)

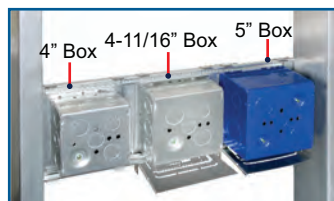

ANY SIZE J-BOX

SSB-T5 fits up to three 4", 4-11/16" or 5" boxes between 24" studs

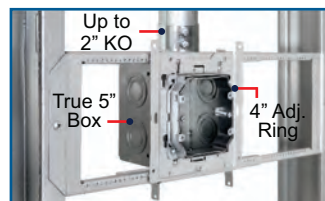

SSB-T5 INSTALLED

Use **5SLB-2MKO** (pg. P28) or **T5B's** (pg. P27) for 1-1/4" or larger conduit

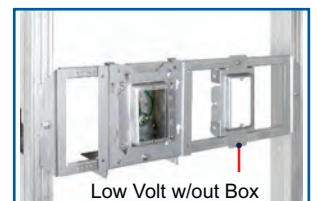

POWER + DATA

Use LVSB1 or 2 for Low Voltage applications that do not require a junction box

PATENTED

ORBIT INDUSTRIES EXCLUSIVE



Video Available On Our Website!

SIMPLE SUPPORT BRACKETS FAMILY

PRODUCT FEATURES

- ▶ **SSB Brackets** adjust from 15" to 25", rigidity eliminates need for farside back support
- ▶ **SSB Brackets** accept 4", 4-11/16" & 5" Sq. Boxes; must be paired with UMA-LVBS to mount 5" Sq. Boxes
- ▶ **SSB Brackets** expand without removing adapters or junction boxes (ideal for prefabrication)
- ▶ ***SSB-T5** installs between wall studs or overhead between hard lid ceiling joists
- ▶ **SSB-TBAR** includes two riveted clips for T-bar drop ceiling installation
- ▶ Must use **5SLB-2MKO** (pg. P28) or **T5B's** (pg. P27) with **SSB Brackets** for 1-1/4" or larger conduit
- ▶ **UMA, UMA-LVBS's, UMAB's & UMIAB's** either mount direct-to-stud or clip onto **SSB Brackets**
- ▶ **UMA** compatible with all Orbit Adj. Rings
- ▶ **UMA-LVBS's** compatible with all Orbit Adj. Rings except for *SAR2G models; allows for *AR2G-58 models to mount vertical or horizontal
- ▶ **UMA-LVBS's** allow 4" rings to be mounted independently of boxes, can be used with any size box
- ▶ **UMAB's & UMIAB's** ship with boxes set at 5/8" raise
- ▶ **UMAB's & UMIAB's** are ideal for Life Safety systems rough-in
- ▶ **LVSB1 & LVSB2** eliminate need for an electrical box in low voltage applications on **SSB Brackets**
- ▶ See pg. P2 – P8 for more SSB System Product Features

NOTE

- ▶ **SSB Brackets** must be accompanied with either **UMA** or **UMA-LVBS's** to mount a junction box. **UMAB's/UMIAB's** also snap onto **SSB Brackets**.
- ▶ Made in USA SSB-T5 available upon request

Cat. No.	Description	Std. Pkg.
*SSB-T5	Simple Support Bracket adjusts from 15" to 25" for mounting 4", 4-11/16" & 5" Sq. boxes between studs 25	
SSB-TBAR	SSB-T5 with T-bar Drop Ceiling Mounting Clips	20
UMA	Universal Mounting Adapter for 4" and 4-11/16" Sq. boxes & multigang boxes to mount to SSB-T5, 25 SSB-TBAR, USB and directly to stud. Break in half to mount multigang boxes	
*UMA-LVBS	Universal Mounting Adapter w/ Back Support (up to 6"), allows for 4", 4-11/16" & 5" Sq. boxes to mount to SSB-T5, SSB-TBAR, USB and directly to stud	25
*US-UMA-LVBS <small>NEW</small>	Made in USA UMA-LVBS	25
UMIAB-35 <small>NEW</small>	Internal Adjustment 4" Square, 3-1/2" Deep Box, 46 Cu. In., Adj. range: 1/2" to 1-1/2"	10
FA-UMIAB-35 <small>NEW</small>	Internal Adjustment Red 4" Square, 3-1/2" Deep Box, 46 Cu. In., Adj. range: 1/2" to 1-1/2"	10
UMAB	External Adjustment 4" Square, 3-1/2" Deep Box, 46 Cu. In., Adj. range: 0" to 1-1/2"	10
FA-UMAB	External Adjustment Red 4" Square, 3-1/2" Deep Box, 46 Cu. In., Adj. range: 0" to 1-1/2"	10
UMAB-4R	External Adjustment 4" (4O), 2-1/8" Deep Box w/ 10" PT, 21.1 Cu. In., Adj. range: 0" to 1-1/2"	20
FA-UMAB-4R	External Adjustment Red 4" (4O), 2-1/8" Deep Box, 21.1 Cu. In., Adj. range: 0" to 1-1/2"	20
LVSB1	Low Voltage Stud Mounting Bracket 1-Gang, 1/2" raise	50
LVSB2	Low Voltage Stud Mounting Bracket 2-Gang, 1/2" raise	25
BMCS	Box Mounted Conduit/Cable Support	50
BMCS-CJ6	Box Mounted Conduit/Cable Support w/ CS-CJ6 installed	50

**UMA-LVBS Spec updated May 2023*

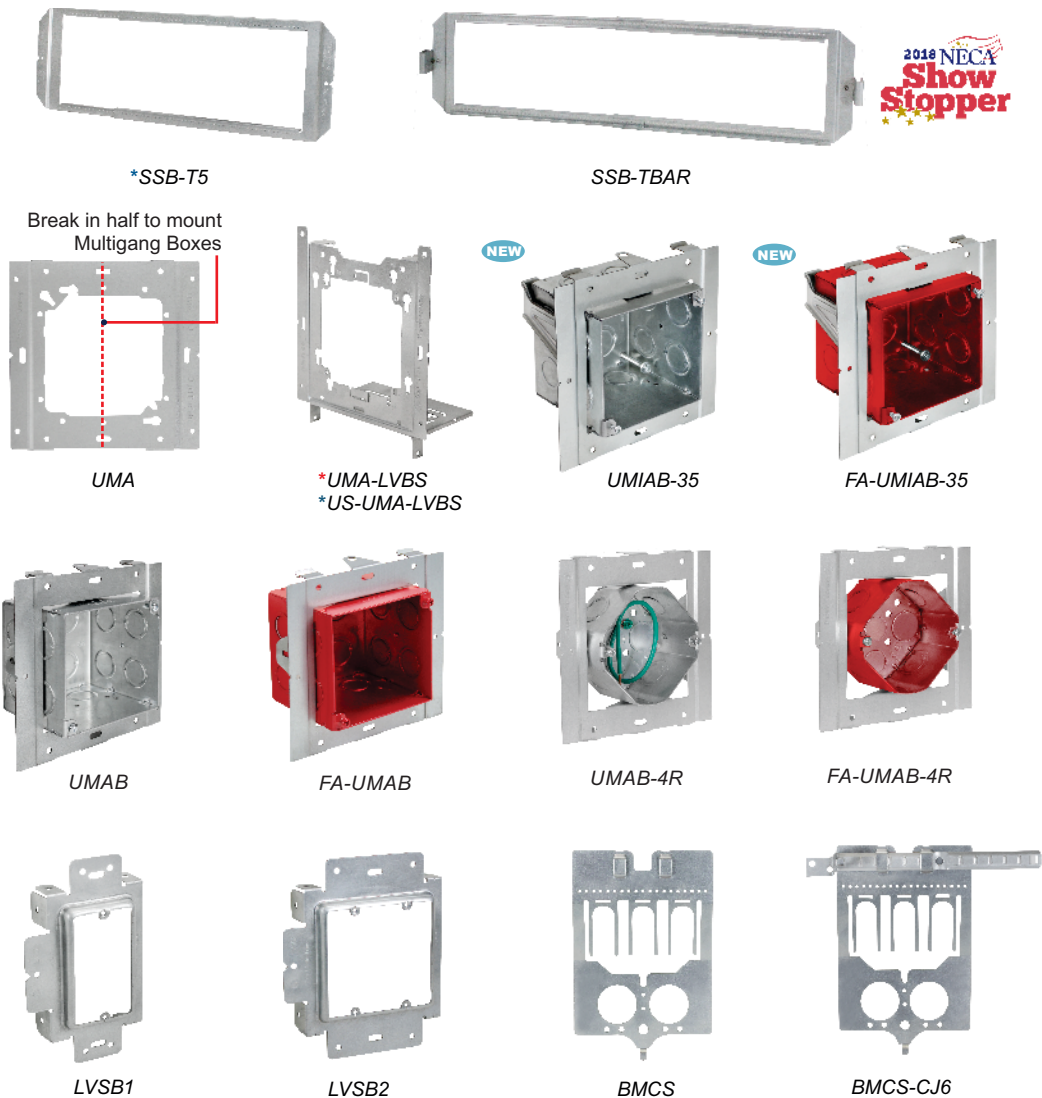

Video Available On Our Website!





UMIAB-35 FEATURES

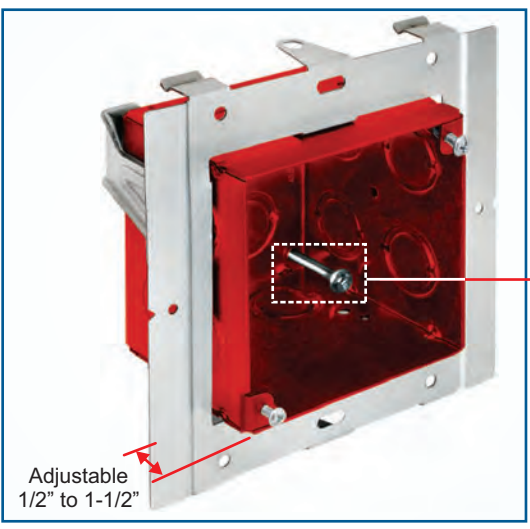
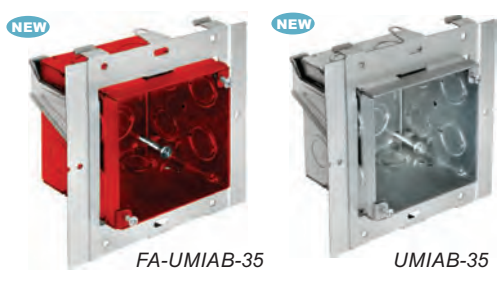

TRI-COMBO HEX SCREW



INTERNAL ADJUSTMENT

Internal adjustment screws allow the box to be adjusted before and after installation

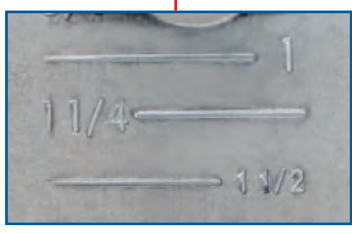

DEPTH MARKING

Engraved depth stamp on box allows for depth measurement without requiring additional measuring tools

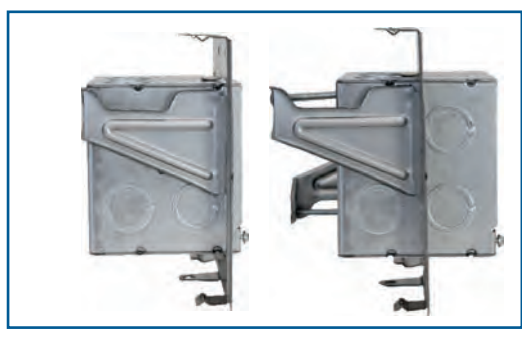

ADJUSTABILITY RANGE

1/2" to 1-1/2"

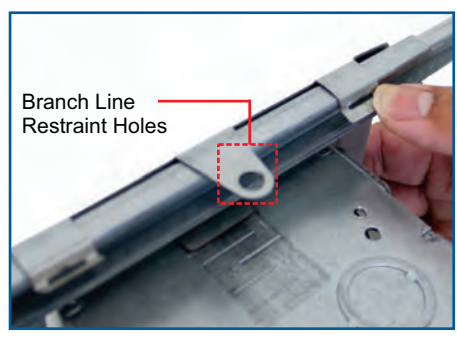

ADAPTER TO BRACKET LATCH

Fold tabs to secure adapter on SSB Brackets

DIRECT-TO, BETWEEN STUDS & OVERHEAD APPLICATIONS



DIRECT TO STUD



BETWEEN STUDS



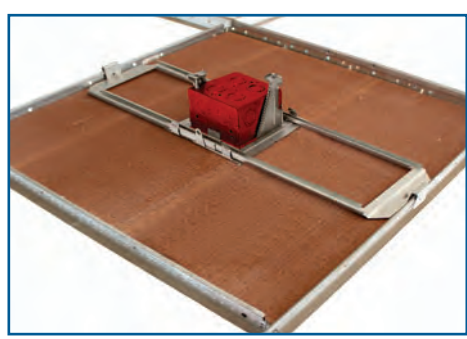







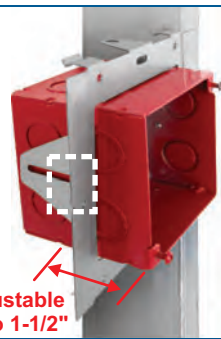











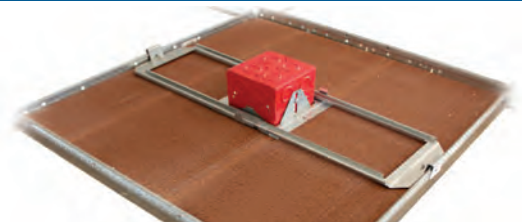

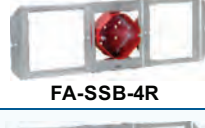

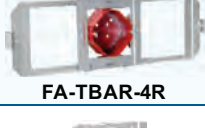

FA-UMIAB-35 Installed on SSB-T5



DROP CEILING APPLICATION

FA-UMIAB-35 Installed on SSB-TBAR

IN-STOCK, PRE-ASSEMBLED ROUGH-IN PRODUCTS

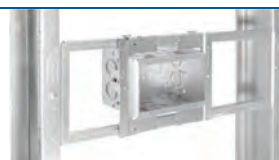
	Cat No.	Std. Pkg	Installation Image	Cat No.	Std. Pkg	Installation Image
FIRE ALARM	 UMAB	10	 Adjustable 0" to 1-1/2"	 UMIAB-35	10	 Adjustable 1/2" to 1-1/2"
	 FA-UMAB	10		 FA-UMIAB-35	10	
	Cat No.	Components		Std. Pkg	Installation Images	
	 FA-SSB-UMAB	 SSB-T5	 FA-UMAB	10		
 FA-TBAR-UMAB	 SSB-TBAR	 FA-UMAB	10			
SMOKE DETECTOR	 FA-UMAB-4R	-	-	20	 Direct-to-Stud	
	 FA-SSB-4R	 SSB-T5	 FA-UMAB-4R	20	 FA-SSB-4R Shown Installed in hard lid ceiling UMAB-4R Shown Installed on SSB-T5	
	 FA-TBAR-4R	 SSB-TBAR	 FA-UMAB-4R	20		
LIGHTING	 UMAB-4R	-	-	20	 2024 NECA Show Stopper FA-TBAR-4R and SSB-T4R Shown Installed in T-Bar ceiling	
	 SSBT-4R	 SSB-TBAR	 UMAB-4R	20		
MULTI-GANG	 SSB-MB3 (Shown)	 SSB-T5	 MB-3	10		

See Page P2 for more Multigang Box on SSB Models

