



Orbit carries an extensive variety of Fastening and Support products for electrical and datacom installations. Many of Orbit's Fasteners are composed of Spring Steel material, which are incredibly versatile, and often require no tools to install. Orbit constantly evaluates its product mix to ensure contractors have access to the products they need. Our vast Fastener and Support selection includes Spring Steel Cable & Conduit Clips, Wall Mounted Box Brackets, Ceiling Hangers & Plates, Datacom Support Products, and more.

Cable & Conduit



Straps



Stud Wall

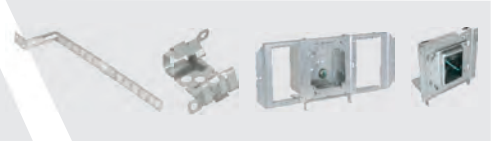

Box & Conduit Support



T-Grid Clips & Hangers

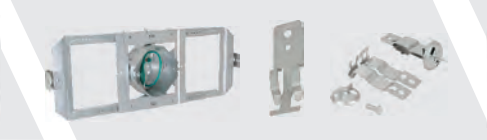

Bar Hangers



Beam & Purlin



Datacom & Low Voltage



Accessories



Electrical Fasteners

MATERIALS

SPRING STEEL & SHEET STEEL



Spring Steel



Sheet Steel

Orbit's Fasteners are available in a variety of sizes and two basic steel materials.



Universal Mounting Adapter with Back Support | Pg. F18

Universal Mounting Adapter with Back Support (UMA-LVBS) is one of the few mounting adapters of its kind that accepts 4", 4-11/16", and now 5" square boxes. UMA-LVBS features a unique keyhole pattern that allows any size box to be turned 90°. Keyholes also allow 4" rings to be paired with any 4-11/16" or 5" square box. Integrated back support for up to 6" stud depths. Mounts direct-to-stud or between studs with SSB-T5. The adapter, boxes and/or rings to all be mounted vertically or horizontally to facilitate different applications!

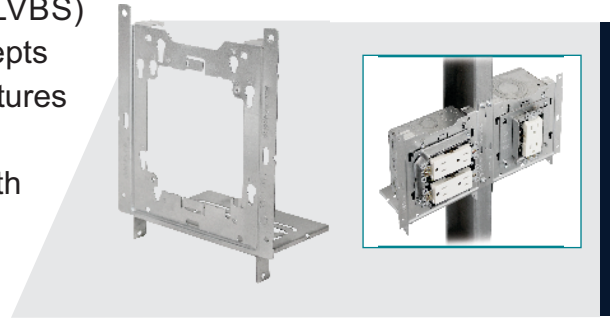

Independent Acoustical Support Clips | Pg. F27

Independent Acoustical Support Clips provide a means to support lighting fixtures from common 15/16" T-grid ceiling channel. ISC requires no tools to install and can support fixtures 65 lbs. or under. Each ISC kit includes a break apart T-grid perimeter clip which cinches both sides of the channel and includes pre-punched holes for branch line restraints. Also includes 5/8" long screw and washer-wingnut.

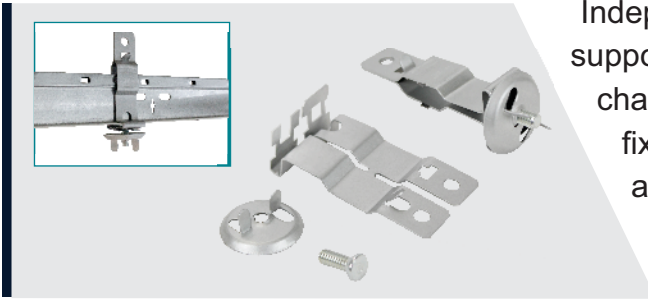

Electrical Fasteners

Spring Steel Beam Clamps | Pg. F33

Spring Steel Beam Clamps make it easy to suspend threaded rod from beam flanges. BCSS includes a set screw with universal head and features serrated teeth that clamp tightly to beam flanges up to 1/2" thick. BCSS also features 7/16" thru-hole for 1/4" or 3/8" threaded rod, and will hold up to 100 lbs.

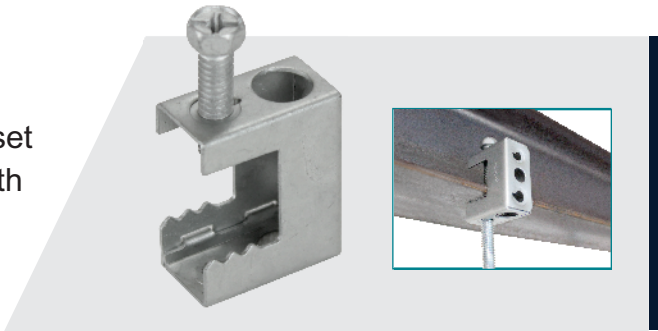

Datacom Cable J-Hooks | Pg. F37

Datacom Cable J-Hooks provide superior support for Cat 5E, Cat 6, Cat 6A, Cat 7 and fiber optic network cables. CAT Series J-Hooks are available in 3/4" thru 4" diameters and feature rounded edges for proper cable bend radius. Prepunched holes allow for attachment of rod clips or beam clamps.

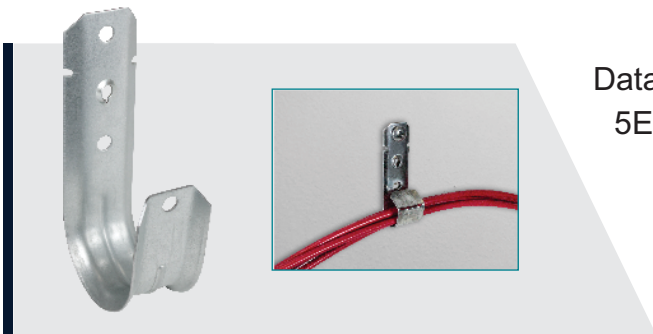

STEEL BRIDLE RINGS

PRODUCT FEATURES

- ▶ Zinc Electroplated
- ▶ Supports low voltage communication cables from beams, rods or purlins combined with other Orbit fasteners

Cat. No.	Diameter	Tread Size	Screw Type	Std. Pkg.
F2BRT12	3/4"	#10-24	Metal	100
F2BRT20	1-1/4"	#10-24	Metal	100
F2BRT32	2"	#10-24	Metal	100
F4BRT20	1-1/4"	1/4"-20	Metal	100
F4BRT32	2"	1/4"-20	Metal	100
F4BRT32WS	2"	1/4"-10	Wood	100
F4BRT64	4"	1/4"-20	Metal	50



STEEL J-HOOKS

PRODUCT FEATURES

- ▶ Pre-galvanized Steel
- ▶ Cost effective alternative to expensive cable tray
- ▶ Galvanized finish on J-Hooks provides smoother cable pull and greater corrosion resistance
- ▶ Supports fiber optic, innerduct and low voltage cable

Cat. No.	Diameter	Std. Pkg.
FCAT12	3/4"	50
FCAT21	1-5/16"	50
FCAT32	2"	50
FCAT64	4"	25

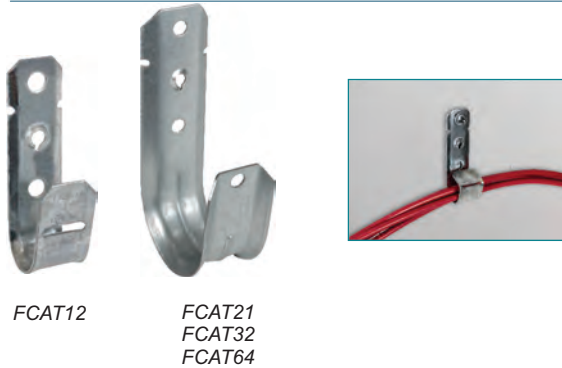

STEEL J-HOOKS WITH ROD/WIRE CLIP

PRODUCT FEATURES

- ▶ Pre-galvanized Steel J-hook with spring steel clip
- ▶ Threaded rod attachment with attached J-Hook
- ▶ Support low voltage cables

Cat. No.	Diameter	Flange Thickness	Rod Size	Wire Size	Std. Pkg.
FCAT124Z34	3/4"	1/8" to 3/8"	1/4"	#12 - #8	40
FCAT126Z34	3/4"	3/8" to 7/16"	3/8"	-	60

