

SIMPLE SUPPORT BRACKETS FAMILY

PRODUCT FEATURES

- ▶ **SSB Brackets** adjust from 15" to 25", rigidity eliminates need for farside back support
- ▶ **SSB Brackets** accept 4", 4-11/16" & 5" Sq. Boxes; must be paired with UMA-LVBS to mount 5" Sq. Boxes
- ▶ **SSB Brackets** expand without removing adapters or junction boxes (ideal for prefabrication)
- ▶ ***SSB-T5** installs between wall studs or overhead between hard lid ceiling joists
- ▶ **SSB-TBAR** includes two riveted clips for T-bar drop ceiling installation
- ▶ Must use **5SLB-2MKO** (pg. P28) or **T5B's** (pg. P27) with **SSB Brackets** for 1-1/4" or larger conduit
- ▶ **UMA, UMA-LVBS's, UMAB's & UMIAB's** either mount direct-to-stud or clip onto **SSB Brackets**
- ▶ **UMA** compatible with all Orbit Adj. Rings
- ▶ **UMA-LVBS's** compatible with all Orbit Adj. Rings except for *SAR2G models; allows for *AR2G-58 models to mount vertical or horizontal
- ▶ **UMA-LVBS's** allow 4" rings to be mounted independently of boxes, can be used with any size box
- ▶ **UMAB's & UMIAB's** ship with boxes set at 5/8" raise
- ▶ **UMAB's & UMIAB's** are ideal for Life Safety systems rough-in
- ▶ **LVSB1 & LVSB2** eliminate need for an electrical box in low voltage applications on **SSB Brackets**
- ▶ See pg. P2 – P8 for more SSB System Product Features

NOTE

- ▶ **SSB Brackets** must be accompanied with either **UMA** or **UMA-LVBS's** to mount a junction box. **UMAB's/UMIAB's** also snap onto **SSB Brackets**.
- ▶ Made in USA SSB-T5 available upon request

Cat. No.	Description	Std. Pkg.
*SSB-T5	Simple Support Bracket adjusts from 15" to 25" for mounting 4", 4-11/16" & 5" Sq. boxes between studs 25	
SSB-TBAR	SSB-T5 with T-bar Drop Ceiling Mounting Clips	20
UMA	Universal Mounting Adapter for 4" and 4-11/16" Sq. boxes & multigang boxes to mount to SSB-T5, 25 SSB-TBAR, USB and directly to stud. Break in half to mount multigang boxes	
*UMA-LVBS	Universal Mounting Adapter w/ Back Support (up to 6"), allows for 4", 4-11/16" & 5" Sq. boxes to mount to SSB-T5, SSB-TBAR, USB and directly to stud	25
*US-UMA-LVBS <small>NEW</small>	Made in USA UMA-LVBS	25
UMIAB-35 <small>NEW</small>	Internal Adjustment 4" Square, 3-1/2" Deep Box, 46 Cu. In., Adj. range: 1/2" to 1-1/2"	10
FA-UMIAB-35 <small>NEW</small>	Internal Adjustment Red 4" Square, 3-1/2" Deep Box, 46 Cu. In., Adj. range: 1/2" to 1-1/2"	10
UMAB	External Adjustment 4" Square, 3-1/2" Deep Box, 46 Cu. In., Adj. range: 0" to 1-1/2"	10
FA-UMAB	External Adjustment Red 4" Square, 3-1/2" Deep Box, 46 Cu. In., Adj. range: 0" to 1-1/2"	10
UMAB-4R	External Adjustment 4" (4O), 2-1/8" Deep Box w/ 10" PT, 21.1 Cu. In., Adj. range: 0" to 1-1/2"	20
FA-UMAB-4R	External Adjustment Red 4" (4O), 2-1/8" Deep Box, 21.1 Cu. In., Adj. range: 0" to 1-1/2"	20
LVSB1	Low Voltage Stud Mounting Bracket 1-Gang, 1/2" raise	50
LVSB2	Low Voltage Stud Mounting Bracket 2-Gang, 1/2" raise	25
BMCS	Box Mounted Conduit/Cable Support	50
BMCS-CJ6	Box Mounted Conduit/Cable Support w/ CS-CJ6 installed	50

**UMA-LVBS Spec updated May 2023*

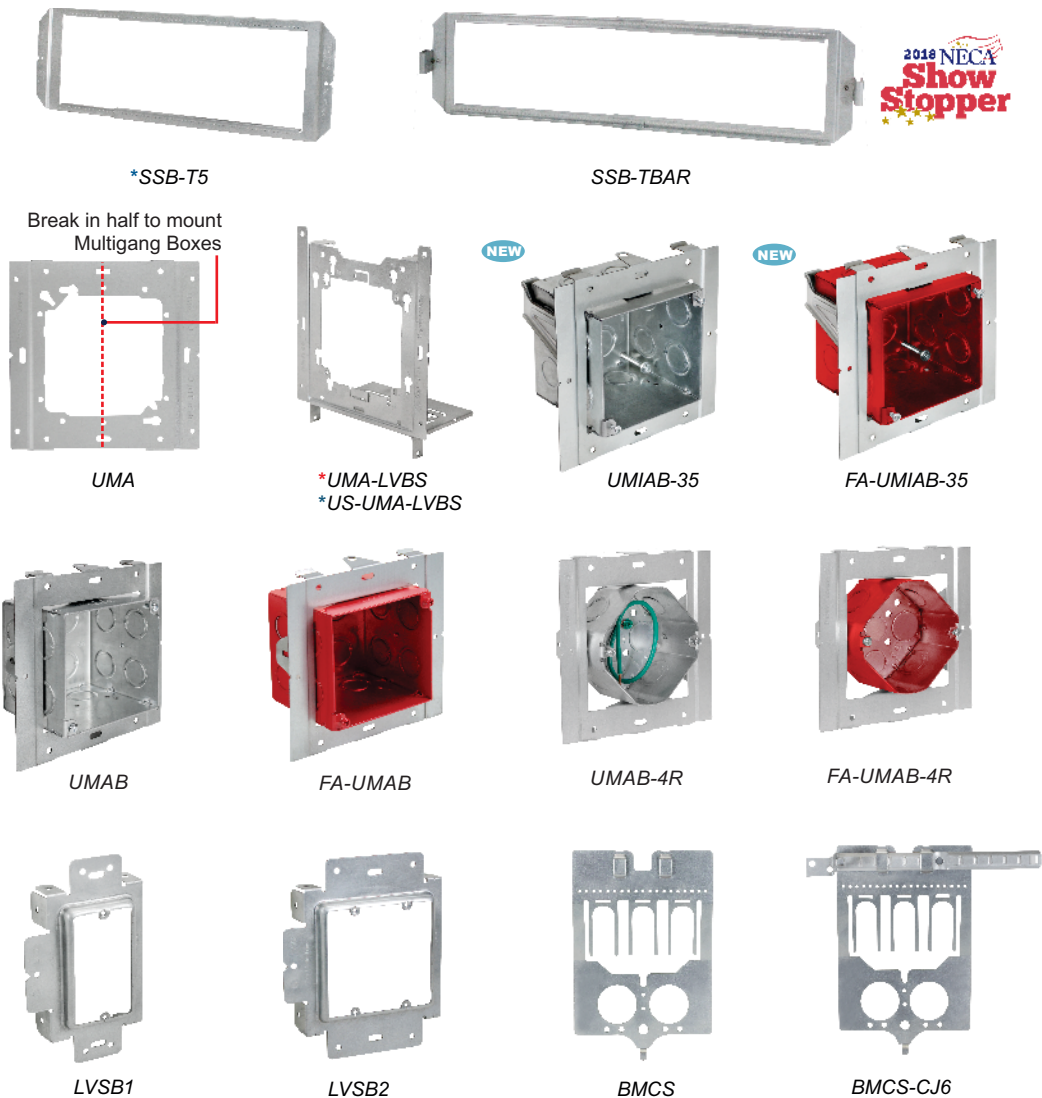

SSB WITH PREASSEMBLED ADJUSTABLE MASON BOX 3-1/2" DEEP

PRODUCT FEATURES

- ▶ **SSB Bracket** adjust from 15" to 25", rigidity eliminates need for farside back support
- ▶ Ships preassembled with box depth set at 5/8", and adjustable up to 1-1/2"
- ▶ Guided-slots on each side allow the box depth to be easily adjusted by simply loosening the screws
- ▶ Built-In Adapter allows Masonry Box to be moved along SSB Bracket until set in final position with a Tek screw
- ▶ All Knockouts are Concentric 1/2" & 3/4"

Cat. No.	No. of Gangs	KO Ends	KO Bottom	KO Sides	Cu. Inches	Std. Pka.
SSB-MB3	3	(6) - CKO	(3) - CKO	(4) - CKO	69.3	10
SSB-MB4	4	(8) - CKO	(4) - CKO	(4) - CKO	92.1	10
SSB-MB5	5	(10) - CKO	(5) - CKO	(4) - CKO	116.1	10
SSB-MB6	6	(12) - CKO	(6) - CKO	(4) - CKO	139	10

PATENTED

READY TO INSTALL



SSB-MB3



6-way Adjustability



Ex.: Nurse Call Systems
An ideal solution in Nurse Call systems and Headwall assemblies for healthcare projects.

SSB-MB3 SIDE VIEW



Adjustment Screws & Guided Slots

Adjustable 5/8" to 1-1/2"

BOX MOUNTED CONDUIT/ CABLE SUPPORT

PRODUCT FEATURES

- ▶ Eliminates need for field installed first means of support
- ▶ Attaches directly to any size junction box for a cost-saving solution to first means of support needs
- ▶ Complies with NEC 330.30 (B)
- ▶ Eliminates the need for additional bar hangers in the field
- ▶ BMCS-CJ6 includes a CS-CJ6 for tool-less cable installation

Cat. No.	Description	Std. Pka.
BMCS	Box Mounted Conduit Cable Support	50
BMCS-CJ6	Box Mounted Conduit Cable Support with CS-CJ6 for tool-less installation	50
CS-CJ6	Stud Mounting Cable Support with locking tab	100



BMCS

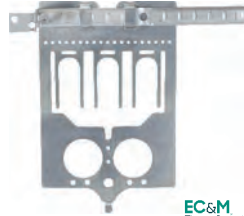

BMCS-CJ6

EC&M Product of the Year 2020
2020 Category Winner



CS-CJ6



Neat, efficient packaging - prevents individual pieces from linking together

PATENT PENDING

ORBIT INDUSTRIES EXCLUSIVE



TRADITIONAL METHOD

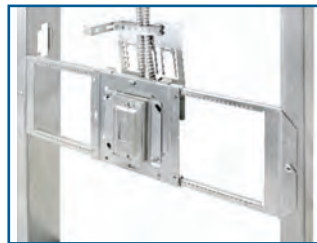

BMCS-CJ6

Installed on box to minimize field work & eliminates need for additional bar hanger



Installed with just one Wafer Head Screw

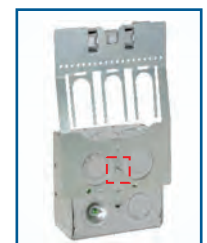

FIRST MEANS OF SUPPORT OPTIONS

CS-CJ6

Secures up to 4 MC/AC Cables without tools



Secures to back of junction box with ONE Wafer Head screw!

Insert tab into lower screw hole on junction box

PIN HOLES

Pin holes allow for installation up to 2" straps

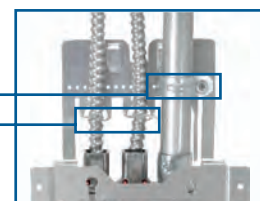

FORKS

Support up to 3 MC/AC Cables without tools



BOX ADAPTER FEATURES

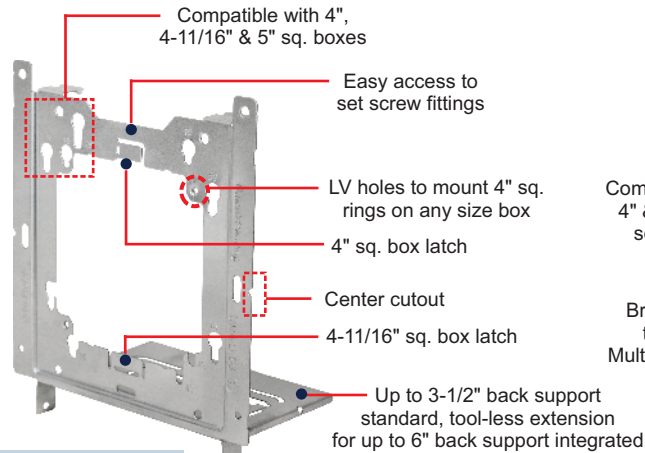

UMA-LVBS
*US-UMA-LVBS

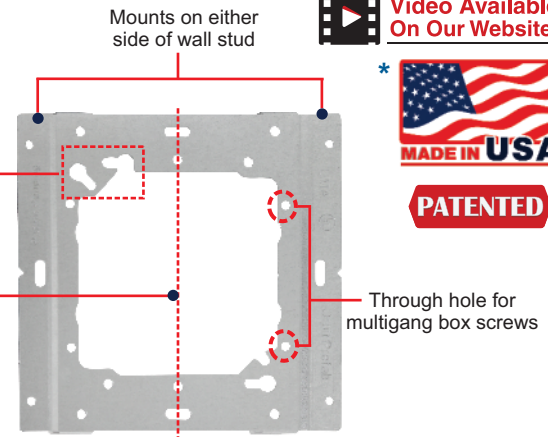

UMA

Video Available On Our Website!



PATENTED

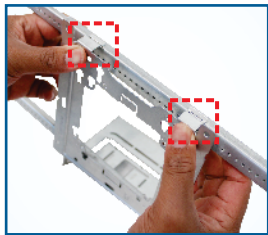

Adapters easily SNAP onto SSB Brackets

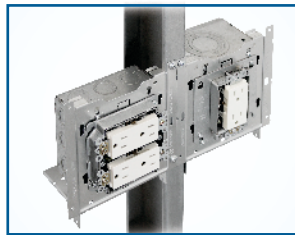

Pair 4" rings with any 4-11/16" or 5" sq. box with UMA-LVBS

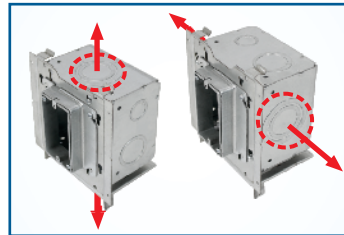

Turn any 4", 4-11/16" and 5" sq. box 90° with UMA-LVBS

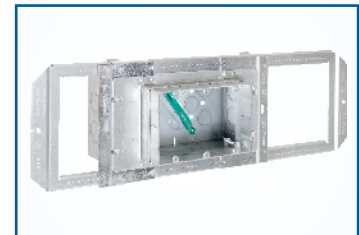

Break UMA in half to mount Multigang Boxes

SSB-T5 FEATURES

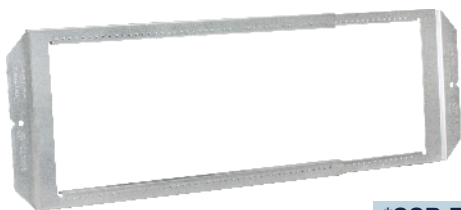

*SSB-T5

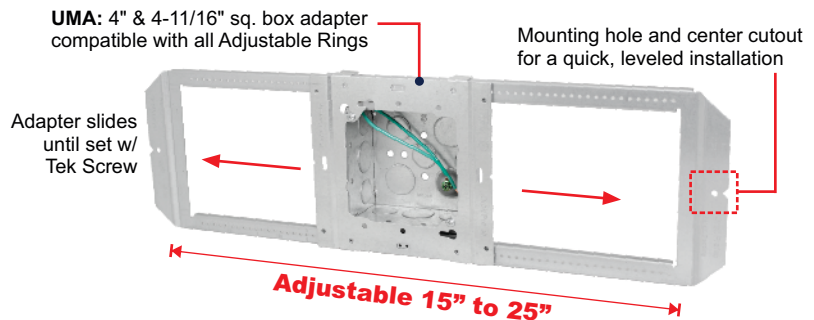

Order preassembled with box and 10" pigtail as SSB-4S-MKO, SSB-A4, SSB-5S-MKO or SSB-T5B-200 (pg. P7)

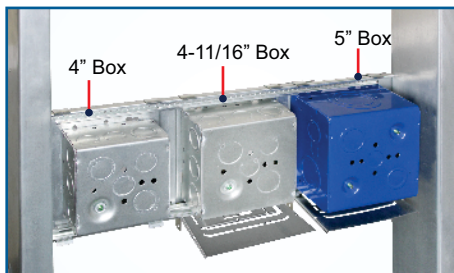

ANY SIZE J-BOX

SSB-T5 fits up to three 4", 4-11/16" or 5" boxes between 24" studs

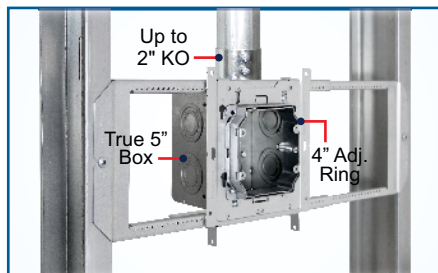

SSB-T5 INSTALLED

Use 5SLB-2MKO (pg. P28) or T5B's (pg. P27) for 1-1/4" or larger conduit

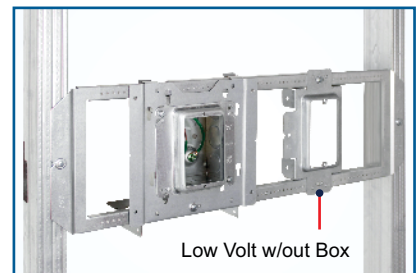

POWER + DATA

Use LVSB1 or 2 for Low Voltage applications that do not require a junction box

UMA-LVBS FEATURES

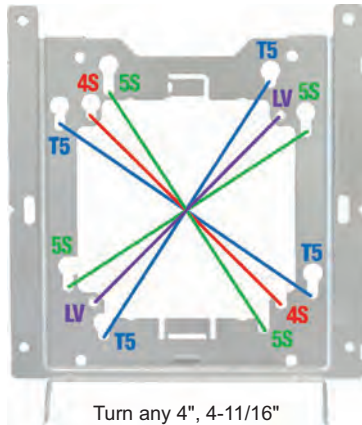

Turn any 4", 4-11/16" and 5" Sq. Box 90°

- ▶ LV= 4" ring
- ▶ 4S= 4" sq.
- ▶ 5S= 4-11/16" sq.
- ▶ T5= 5" sq.

BUILT-IN BACK SUPPORT & EXTENSION

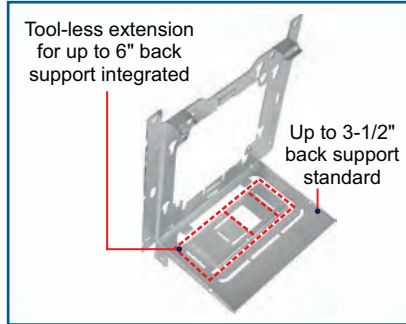

Up to 3-1/2" back support standard

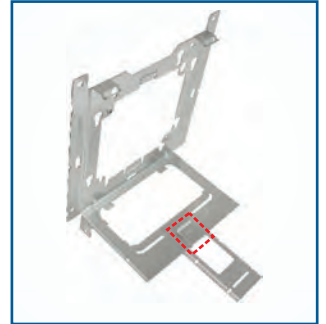

SNAP-OFF

TOOL-LESS INSTALLATION

BOX & ADAPTER LATCHES

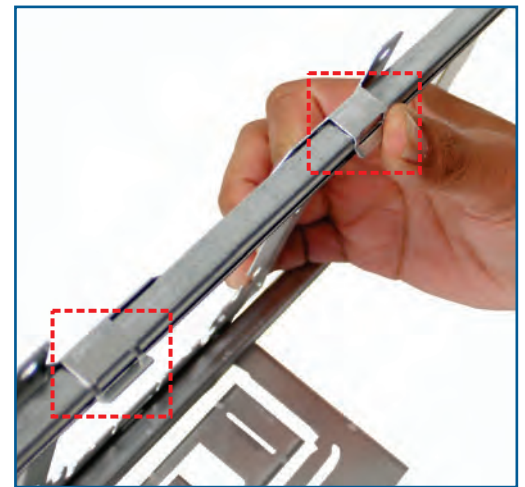
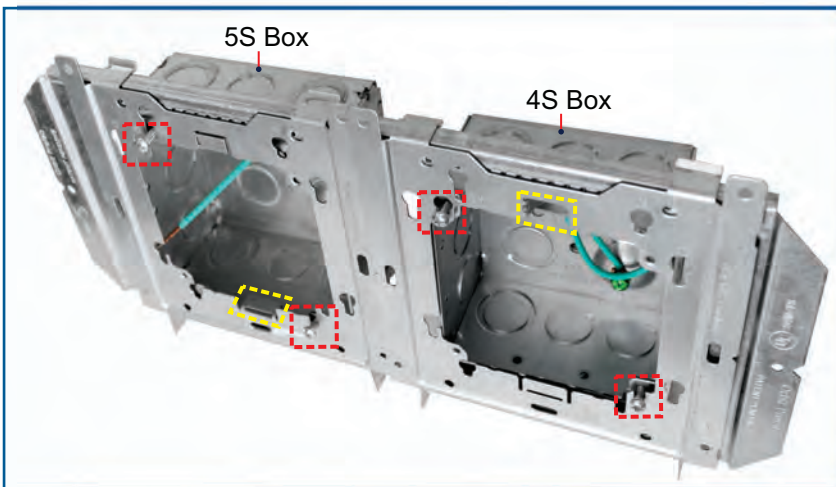

BOX TO ADAPTER LATCH

Bendable latch tabs securely hold 4" or 4-11/16" sq. box in place without need to tighten box screws. Skip hassle of tightening box screws until the final ring installation, making installation process more efficient and convenient.

ADAPTER TO BRACKET LATCH

Fold tab to secure adapter on SSB Brackets

90° ROTATION

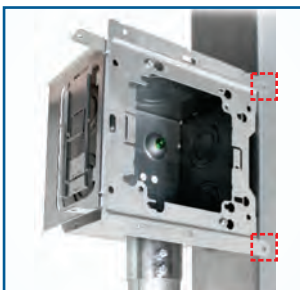

Extended Mounting Tab enables secure mounting with 90° rotation. Box will be able to receive large conduit without removal of back support

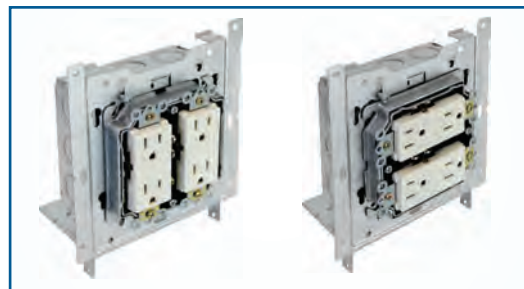

All *AR1G- & *AR2G- rings install vertical or horizontal

STUD MOUNT

VERTICAL & HORIZONTAL RING INSTALLATION



UMIAB-35 FEATURES

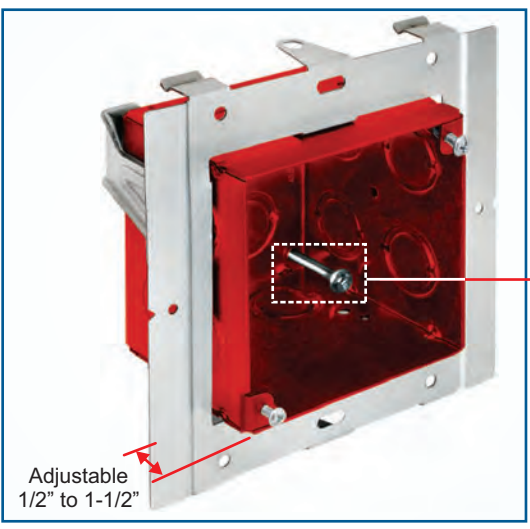
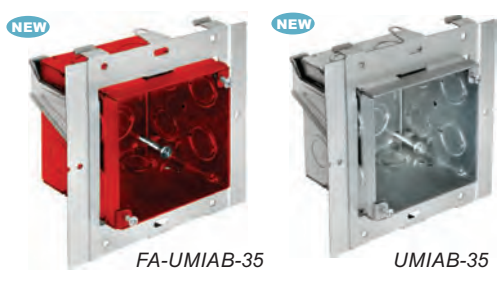

TRI-COMBO HEX SCREW



INTERNAL ADJUSTMENT

Internal adjustment screws allow the box to be adjusted before and after installation

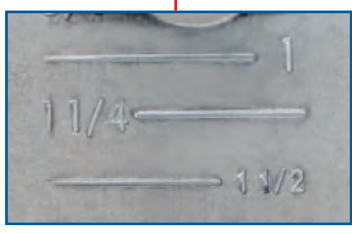

DEPTH MARKING

Engraved depth stamp on box allows for depth measurement without requiring additional measuring tools

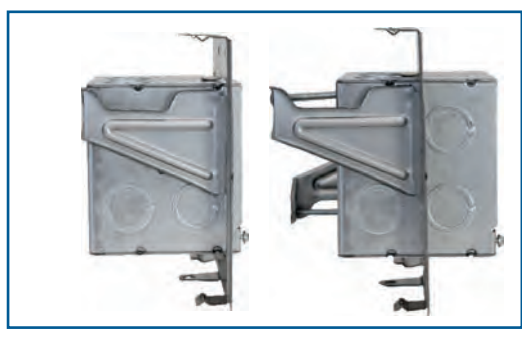

ADJUSTABILITY RANGE

1/2" to 1-1/2"

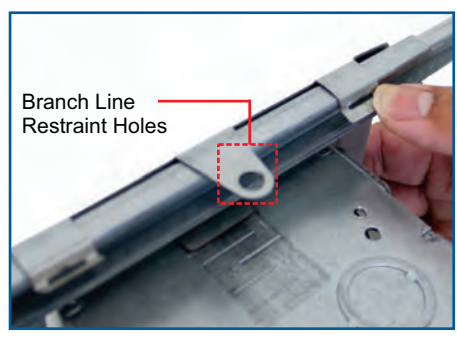

Branch Line
Restraint Holes

ADAPTER TO BRACKET LATCH

Fold tabs to secure adapter on SSB Brackets

DIRECT-TO, BETWEEN STUDS & OVERHEAD APPLICATIONS

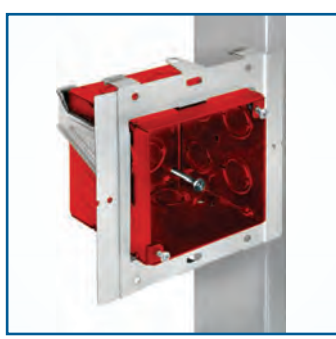

DIRECT TO STUD



BETWEEN STUDS

FA-UMIAB-35 Installed on SSB-T5

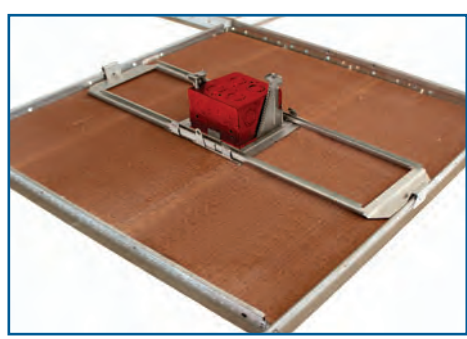

DROP CEILING APPLICATION

FA-UMIAB-35 Installed on SSB-TBAR

DIRECT-TO OR BETWEEN STUDS

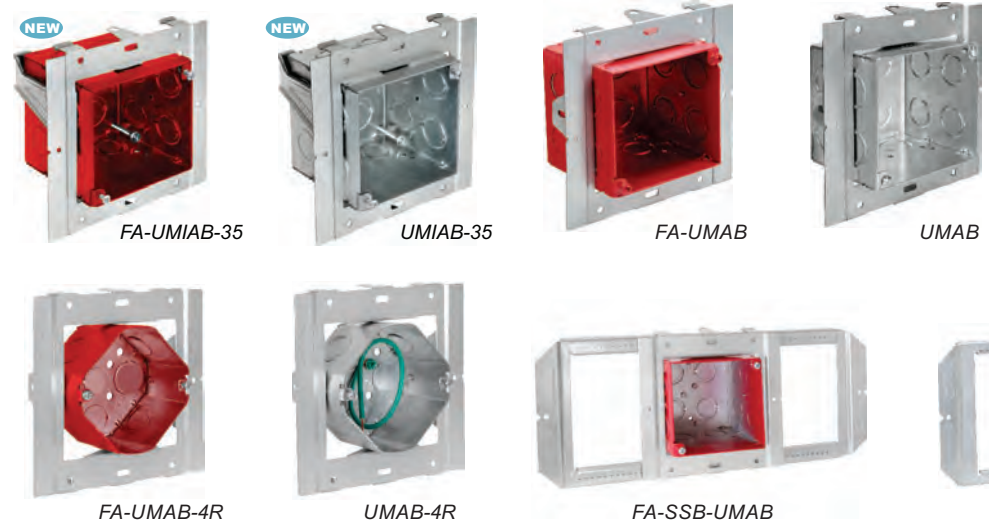

PATENTED



Video Available On Our Website!



Adjustable 0" to 1-1/2"



6-way Adjustability



Branch Line Restraint Holes

6-way Adjustability

DIRECT-TO-STUD

Guided slots on each side allow the box to be easily adjusted by external screws

BETWEEN STUDS

FA-SSB-UMAB Installed Between Studs

ON HARD LID

FA-SSB-4R Installed in Hard Lid Ceiling Joist

DROP CEILING APPLICATIONS

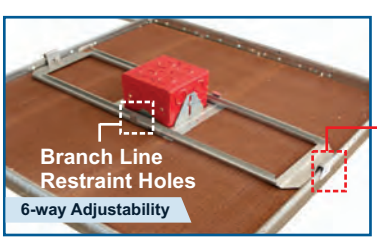

Branch Line Restraint Holes
6-way Adjustability

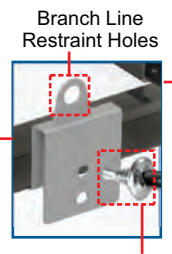

Tek screw provisions on each clip comply with NEC 314.23 (D) (1)

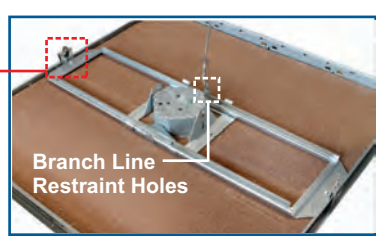

Branch Line Restraint Holes

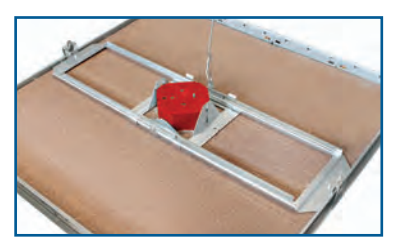

FIRE ALARM ON T-BAR

FA-TBAR-UMAB Installed in Drop Ceiling Grid

SSBT-4R & FA-TBAR-4R ON T-BAR

Shown Installed in Drop Ceiling w/ Branch Line Restraint











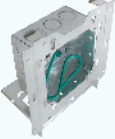

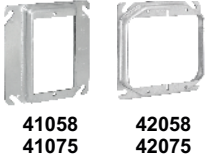

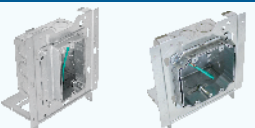

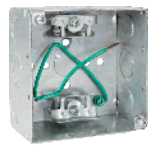



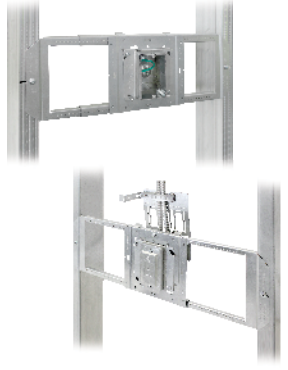

P7 | Ready-to-Install Boxes & Brackets

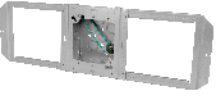

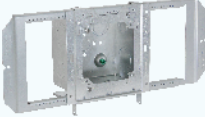
Prefab Products

IN-STOCK, PRE-ASSEMBLED ROUGH-IN PRODUCTS

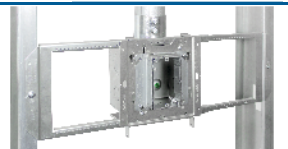
	Cat No.	Components			Std. Pkg	Installation Images		
POWER	 LVBS-4				25			
	 LVBS-4-158 LVBS-4-258 LVBS-4-175 LVBS-4-275							
	 LVBS-4-A158 LVBS-4-A258 LVBS-4-A134	UMA-LVBS	4SDB-MKO-PT-10		25		Shown installed on SSB-T5	
	 LVBS-A4-CS6	UMA-LVBS			25		Shown installed on SSB-T5	
	 LVBS-A4-A158-CS6 <small>EC&M Product of the Year 2022 Cat. Agency National</small>	BMCS-CJ6						
	 SSB-4S-MKO				12			
	 SSB-A4				12			
	 SSB-5S-MKO				12			
	DATA	 SSB-T5B-200					10	

Email info@orbitprefab.com for more information.











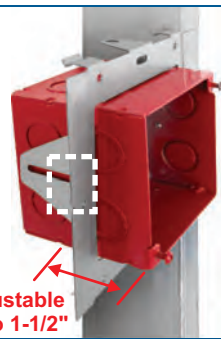











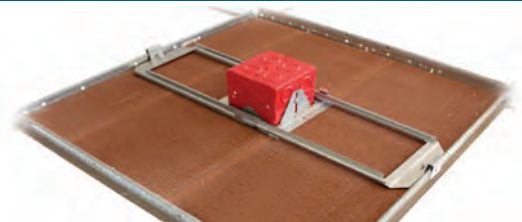

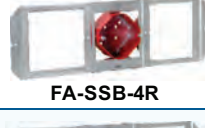

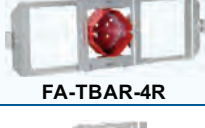

LVBS Assemblies w/ US-UMA-LVBS can be built to order.

Add **"-FS"** to include 2-hour rated Fireblok™ UFSI Insert (UFSI spec on pg. P31)

Add **"-CS"** to include BMCS

Add **"-CS6"** to include BMCS-CJ6
(BMCS spec on pg. P2)

IN-STOCK, PRE-ASSEMBLED ROUGH-IN PRODUCTS

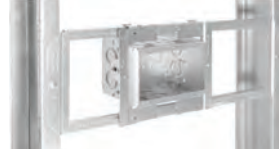
	Cat No.	Std. Pkg	Installation Image	Cat No.	Std. Pkg	Installation Image
FIRE ALARM	 UMAB	10	 Adjustable 0" to 1-1/2"	 UMIAB-35	10	 Adjustable 1/2" to 1-1/2"
	 FA-UMAB	10		 FA-UMIAB-35	10	
	Cat No.	Components		Std. Pkg	Installation Images	
	 FA-SSB-UMAB	 SSB-T5	 FA-UMAB	10		
 FA-TBAR-UMAB	 SSB-TBAR	 FA-UMAB	10			
SMOKE DETECTOR	 FA-UMAB-4R	-	-	20	 Direct-to-Stud	
	 FA-SSB-4R	 SSB-T5	 FA-UMAB-4R	20	 FA-SSB-4R Shown Installed in hard lid ceiling UMAB-4R Shown Installed on SSB-T5	
	 FA-TBAR-4R	 SSB-TBAR	 FA-UMAB-4R	20		
LIGHTING	 UMAB-4R	-	-	20	 2024 NECA Show Stopper FA-TBAR-4R and SSB-T-4R Shown Installed in T-Bar ceiling	
	 SSBT-4R	 SSB-TBAR	 UMAB-4R	20		
MULTI-GANG	 SSB-MB3 (Shown)	 SSB-T5	 MB-3	10		

See Page P2 for more Multigang Box on SSB Models

