

Copper-Clad Steel (CCS) Conductors

Copper-Clad Steel (CCS) conductors are composed of a steel core with a continuous and constant copper cladding that is thoroughly bonded throughout. CCS conductors combine the strength of steel with the high conductivity and corrosion resistance of copper.

CADWELD welded electrical connections have been used to join CCS conductors for over 40 years. The CADWELD exothermic process fuses the CCS conductors together to form a connection that will not corrode, loosen, or increase in resistance for the intended service life of the installation. CCS conductors may also be welded to copper conductors, rebar or any other horizontal or vertical steel surface or structure for electrical grounding.

CADWELD welded electrical connections are preferable to mechanical connections for CCS conductors. Mechanical connections rely on the deformation of the conductors and the pressure exerted by the connector on the conductor to reduce the contact resistance. Since the core of CCS conductors is steel, a CCS conductor will not deform as much as a pure copper conductor and therefore an exothermically welded connection is better suited for this application.

How to Order CADWELD Products

This catalog lists the most popular CADWELD connections for CCS construction. Look in the index for the connection you need. If you cannot find the connection you need, contact Pentair or your local distributor or agent.

1. What connection do you require?

Available connections are listed in the pictorial index, which also shows the degree of difficulty in making the connection, and ease of mold cleaning. We strongly recommend that wherever possible you use molds listed in this catalog. After selecting the connection, turn to the appropriate page and select the mold, welding material and tools you need.

2. What are the conductor sizes?



This catalog covers connections between CCS conductors to each other, to concentric stranded copper cable, to lugs, to ground rods, to rebar, and to rail. For sizes not listed, contact Pentair or your local distributor or agent.

Note: Other Pentair catalogs describe connections to conductors for solid or concentric stranded copper conductors, busbar, lightning protection cable, steel cable, etc.



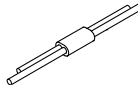
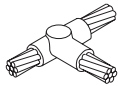
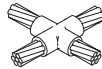
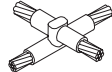
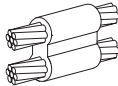
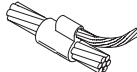



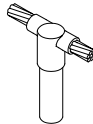
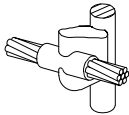

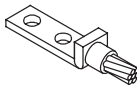
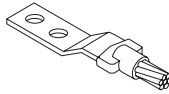
3. You must have the following to make a weld:

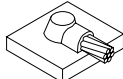
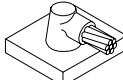
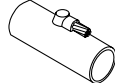
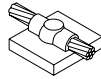
1. CADWELD engineered mold.
2. Welding material required by your mold.
3. Handle clamps and or frame.
4. CADWELD PLUS control unit or flint ignitor.
5. Lugs, sleeves, packing material listed on the page with the mold as required.

CABLE TO CABLE					
Name	Page	Type		Ease	Split
Horizontal Splice	5	SS		1	Vertical
Horizontal Tee	6	TA		1	Horizontal
Horizontal X, Same Plane	9	XA		1	Horizontal
Horizontal X	9	XB		1	Horizontal
Parallel Tap	10	PT		1	Vertical
Horizontal Parallel	11	PC		1	Vertical

CABLE TO GROUND ROD					
Name	Page	Type		Ease	Split
Ground Rod Splice	12	GB		1	Vertical
Cable to Ground Rod - Tap	13	GR		1	Vertical
Cable to Ground Rod - Through	15	GT		1	Vertical
Cable to Ground Rod - Through / Side	17	GY		1	Vertical

CABLE TO LUG					
Name	Page	Type		Ease	Split
Cable to Lug	28	GL		1	Vertical
Cable to Lug	29	LA		1	Horizontal

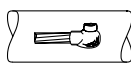
CABLE TO STEEL					
Name	Page	Type		Ease	Split
Horizontal Steel Surface	19	HA		1	*
Horizontal Steel Surface	19	HS		1	*
Horizontal Steel Pipe	20	HA, Pipe		1	*
Horizontal Steel Surface	21	HC		1	*
Horizontal Steel Surface	22	HT		1	*
Vertical Steel Surface	22	VS		1	Vertical
Vertical Steel Pipe	23	VS, Pipe			Vertical
Vertical Steel Surface	24	VF			Vertical
Vertical Steel Surface	24	VB			Vertical
Vertical Steel Surface	25	VT			*
Vertical Steel Surface	25	VG			*
Vertical Steel Surface	26	VV			Vertical
Vertical Steel Surface	27	VN			*

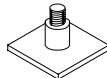
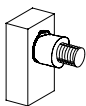
CABLE TO STUD					
Name	Page	Type		Ease	Split
Steel or Copper Studs to Steel Surface	31	HX		1	Vertical
Steel or Copper Studs to Steel Surface	31	HV		1	Horizontal

The CADWELD Mold Numbering System

The CADWELD mold part number gives, in code, the complete information of the mold – type of connection, mold price key, and conductor size(s).

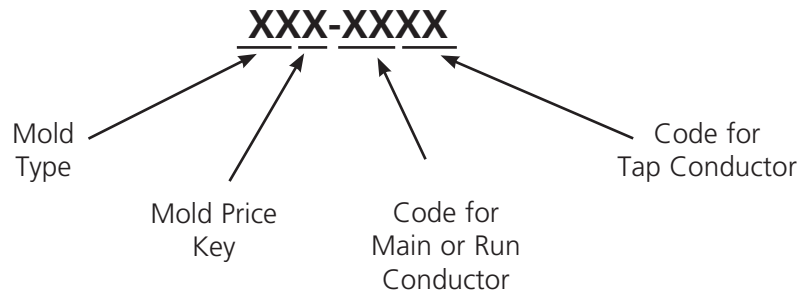

EXAMPLES

TAC-9F9C

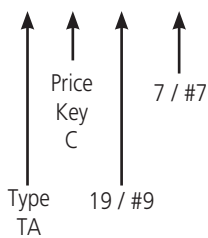

GTC-P16 9H

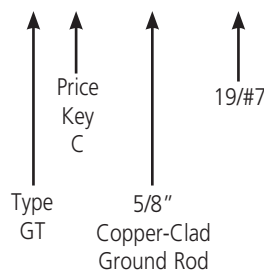

SSC-9F

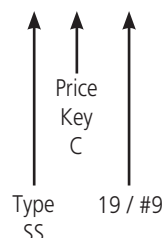

VSC-9D-V5C

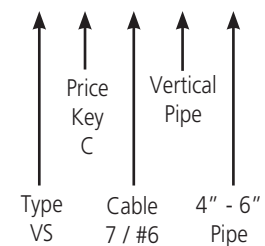

Certain tools may be required for various connections.

If required, these tools are listed on the same page as the connection and in Section A.

- Some tools listed in Section A can save you a lot of time.
- Also refer to A9E, Contractor Tips, to make your job easier, and learn about labor saving ideas.

REQUIRED TOOLS SUMMARY

Required tools are listed with each mold. For your reference, handle clamps and/or frame are summarized below.

<u>MOLD</u>	<u>REQUIRED</u>
A*	Includes frame with handle
C, Q & R	Requires L160
D, F & Z	Requires L159
E*	Includes frame but also requires L160
J*	Includes frame but also requires L159
K*, M* & V*	Includes frame with handles

* To order mold only - without handles or frame - add suffix "M" to mold part number.

For Stranded Copper-Clad Steel Conductors

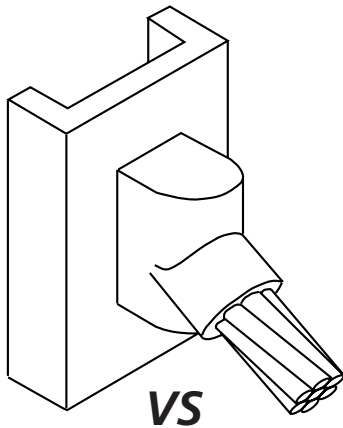

VERTICAL STEEL SURFACE

- Cable down at 45° to vertical steel surface including pipe.
- Cable to vertical flat steel surface; cable to side of vertical or horizontal steel pipe.
- Concentric stranded copper cable listed.
- **A test weld should be made to check the possibility of burn through on thin sections or thin wall pipe.**
- **Bold letter** in mold part number is the price key.

REQUIRED TOOLS

		Part No.
Handle Clamps		
Flat Surface	for C Price Key Molds	L160
	for D Price Key Molds	L159
Pipe	for C Price Key Molds	B160V
	for D Price Key Molds	B159V
	(Pipes 10ø-250 mm dia. add B158)	
CADWELD PLUS Control Unit or Flint Ignitor		PLUSCU T320

SUGGESTED TOOLS

Cable Cleaning Brush	T313 or T314
Mold Cleaning Tool	T394
Mold Cleaning Brush	B265
Rasp	T321
Torch Head	T111

ACCESSORIES

- See Section A

CABLE SIZE (sq mm)	MOLD PART NO.	WELDING MATERIAL ¹
7/#10	V C 9A	65
7/#8	V C 9B	90
7/#7	V C 9C	90
7/#6	V C 9D	115
7/#5	V C 9E	115
19/#9	V C 9F	115
19/#8	V C 9G	150
19/#7	V C 9H	200
19/#6	V C 9J	200

¹For CADWELD PLUS add suffix "PLUSF20" (refer page 44)

Cable to Vertical Steel Pipe –

Use flat surface mold part number; add **V** and suffix.

Cable	Nominal Pipe Diameter	Suffix
7/#10 thru 19/#9	30" and smaller 32" and larger	Nominal Pipe Size None
Example: 7/#7 to 4" pipe, V C 9CV4		
Cable to horizontal steel pipe- Add H and nominal pipe size to flat surface mold number Example: 7/#8 to 8" pipe, V C 9BH8		

CADWELD MOLDS

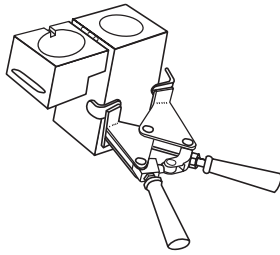

A semi-permanent graphite mold is used for making most CADWELD Connections. The mold controls the direction and speed of the molten CADWELD welding material flow and its final solidified shape. The graphite used in a CADWELD mold is a high temperature type that lasts for an average of 50 or more CADWELD connections under normal usage.

Wear Plates

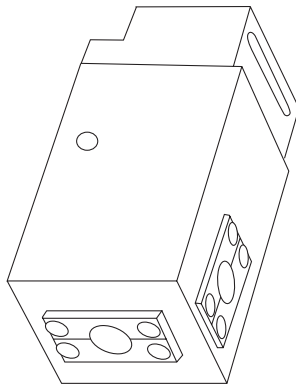

Wear Plates reduce mechanical abrasion of molds at cable entry points and help prevent leakage of molten metal (particularly on larger 7 strand conductor). These features prolong mold life.

Most CADWELD molds are available with factory mounted wear plates for the following sizes:

CCS conductors: 7/#10 thru 19/#6

Ground rods: 1/2" thru 1"

To order WEAR PLATES specify: Mold Part No. followed by the suffix "-W" i.e., TAC9F9FW.

Not available with types HA, HB, HC, LJ, certain PTs, & PCs, RR, VB, VF, VG VN, XA, CXBQ or XBZ.

Following are the number of Wear Plates (W.P.) used on the various types listed in this catalog.

TYPE	W.P.	TYPE	W.P.	TYPE	W.P.
GB	1	HT	2	RC	2
GB-GR	2	LA	1	RD	2
GB-GT	3	LE	2	SS	2
GL	1	LL	1*	TA	3
GR	2	PC	2**	VS	1
GT	3	PT	2**	VT	2
GY	3	RA	1	VV	1
HS	1	RB	2	XB	4

*Available only on molds for 2" and narrower bus size.

**Available only on mold for 7/#10 and larger run and tap.

Split Crucible Molds

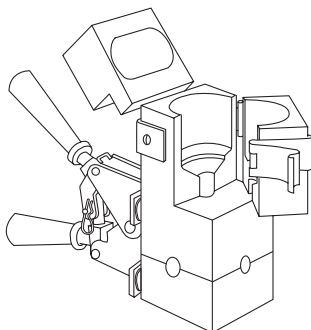

Molds made with a horizontal opening and solid crucible section may be specified as a SPLIT CRUCIBLE TYPE. The SPLIT CRUCIBLE MOLD allows for easier cleaning, but lead times are longer.

To order a SPLIT CRUCIBLE TYPE specify: Mold Part No. followed by the suffix "-L" i.e., TAC2Q2QL.

Available in Type TA, XA, XB, (C & D mold price only), LE and LJ connections.

MOLD FASTENING AND MOUNTING

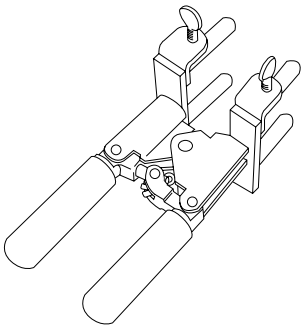

CADWELD Handle Clamps

Handle Clamps such as the one shown are required for most molds. Specialized frames with handles are used on some molds. Flint ignitors are included with all Handle Clamps. The following Handle Clamps are most widely used.

1. L160 for all molds having a "C", "E", "Q", or "R" mold price key. (3" wide molds)
2. L159 for all molds having a "D", "F", "J" or "Z" mold price key. (4" wide molds)

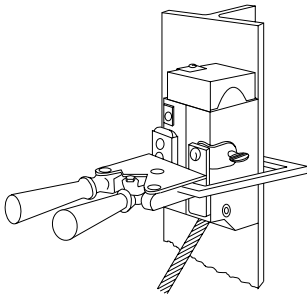

Vertical Surface Mold Support

The CADWELD mold can be securely held to a vertical "H" column or angle by using the Vertical Surface Mold Support. It is easily attached to an existing L159 or L160 Handle Clamp. For use with Types VB, VG, VN, and VS molds, fits steel up to 1" thick, for Type VF mold, 3/4" thick.

- B134: For use with L160 E-Z CHANGE Handle Clamp
 B135: For use with L159 E-Z CHANGE Handle Clamp

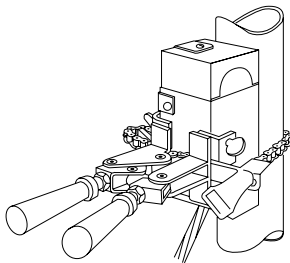

Chain Support Handle Clamps

The CADWELD mold can be securely held to a pipe using the clamp assembly consisting of a modified L159 or L160 Handle Clamp with built-in Pipe Attachment.

Clamp Part No.	Fits Mold Price	For Following Connection Types	Pipe
B159V	D & F	VS, VF, VB, & VV	Vertical
B160V	C & R	VS, VF, VB, & VV	Vertical
B159VT	D & F	VT	Vertical
B160VT	C & R	VT	Vertical
B159H	D & F	HA, HS, HC, & HT	Horizontal
B160H	C & R	HA, HS, HC, & HT	Horizontal

The above clamps are equipped with 20" length of chain which will fit up to 4" pipes. Extra 20" length of chain, B158, is available to fit up to 10" pipes.

Technical Information

COPPER-CLAD STEEL CONDUCTORS

CADWELD Cable Code	Cable Stranding	Nominal Dia. (inches)	Cross Sectional Area (kcmil)
7Y	3/#10	.220	31.15
7X	3/#9 CW	.247	39.28
9Y	3/#8 CW	.277	49.53
9A	7/#10 CW	.306	72.68
9X	3/#7 CW	.311	62.45
9T	7/#9 CW	.343	91.65
9W	3/#6 CW	.349	78.75
9B	7/#8 CW	.385	115.60
9V	3/#5 CW	.392	99.31
9C	7/#7 CW	.433	145.70
9D	7/#6 CW	.486	183.80
9E	7/#5 CW	.546	231.71
9F	19/#9 CW	.572	248.80
9L	7/#4 CW	.613	292.20
9G	19/#8 CW	.642	313.70
9H	19/#7 CW	.721	395.50
7W	37/#9 CW	.801	484.40
9J	19/#6 CW	.810	498.80
7V	37/#8 CW	.899	610.90
9K	19/#5 CW	.910	628.90
9M	37/#7 CW	1.010	770.30

GROUND RODS

Nominal Size	Material	Type	Thread Size	Rod Diameter	CADWELD Ground Rod Code
1/2"	Copper-bonded Steel*	Sectional	9/16"	.505	14
		Plain	–	.500	14
	Copper-bonded	Plain	–	.475	15
	Copper-bonded	Sectional	1/2"	.447	13
5/8"	Copper-bonded Steel*	Sectional	5/8"	.563	16
		Plain	–	.625	31
	Galvanized Steel**	Plain	–	.631	31
	Copper-bonded	Plain	–	.563	16
3/4"	Copper-bonded Steel*	Sectional	3/4"	.682	18
		Plain	–	.750	33
	Copper-bonded	Plain	–	.682	18
1"	Copper-bonded Steel*	Sectional	1"	.914	22
		Plain	–	1.00	37
	Copper-bonded	Plain	–	.914	22

* Plain steel, stainless steel and stainless steel clad rods.

** Manufactured in accordance with NEMA GR-1.

Technical Information

BARE CLASS A, B, AND C CONCENTRIC STRANDED CONDUCTOR

Based on A.S.T.M. Standard Specifications.

CADWELD Cable code	Size in Circular mils	Size A.W.G.	Conductor Dia. In.	NUMBER OF WIRES / Strand Dia. Inches				
				7	19	37	61	91
4Y	1,000,000		1.152			.1644*	.1280	.1048
4Q	800,000		1.031			.1470*	.1145	.0938
4L	750,000		.998			.1424*	.1109	.0908
4G	700,000		.964			.1375*	.1071	.0877
3X	600,000		.893			.1273	.0992	.0812
3Q	500,000		.813		.1622*	.1162	.0905	
3H	400,000		.728		.1451	.1040	.0810	
3D	350,000		.681		.1357	.0973	.0757	
3A	300,000		.630		.1257	.0900	.0701	
2V	250,000		.575		.1147	.0822	.0640	
2Q	211,600	4/0	.528	.1739	.1055	.0756		
2L	167,800	3/0	.470	.1548	.0940	.0673		
2G	133,100	2/0	.419	.1379	.0837	.0600		
2C	105,500	1/0	.373	.1228	.0745	.0534		
1Y	83,690	1	.332	.1093	.0664	.0476		
1V	66,370	2	.292	.0974	.0591			
1Q	52,630	3	.260	.0867	.0526			
1L	41,740	4	.232	.0772	.0469			
1H	26,240	6	.184	.0612	.0372			
1E	16,510	8	.146	.0486	.0295			
1B	10,380	10	.116	.0385	.0234			
	6,530	12	.092	.0305	.0185			
	4,110	14	.073	.0242	.0147			

* Class AA

BARE SOLID COPPER WIRE

Based on A.S.T.M. Standard Specifications

CADWELD Cable code	Size A.W.G.	Cross Sectional Area Circular Mils	Wire Dia. In.
2P	4/0	211,600	.4600
2K	3/0	167,800	.4096
2F	2/0	133,100	.3648
2B	1/0	105,500	.3249
1X	1	83,690	.2893
1T	2	66,370	.2576
1P	3	52,630	.2294
1K	4	41,740	.2043
1G	6	26,250	.1620
1D	8	16,510	.1285
1A	10	10,380	.1019
	12	6,530	.0808
	14	4,110	.0664

Technical Information

RECTANGULAR COPPER BUSBAR

CADWELD Busbar Code	Thickness Inches	Width Inches	Circular Mil Size	Weight Lbs. per Foot
CE CG CH	1/8	1 1-1/2 2	159,200 238,700 318,300	.484 .726 .969
DE DH	3/16	1 2	238,700 477,500	.727 1.45
EE EG EH EK EM	1/4	1 1-1/2 2 3 4	318,300 477,500 636,600 954,900 1,273,000	.969 1.45 1.94 2.91 3.88
GE GG GH GK GM	3/8	1 1-1/2 2 3 4	477,500 716,200 954,900 1,432,000 1,910,000	1.45 2.18 2.91 4.36 5.81
JH JK JM	1/2	2 3 4	1,273,000 1,910,000 2,546,000	3.88 5.81 7.75

CAST IRON PIPE – CLASS A THRU D

AWWA Specification 1908,
ASA A21.2 Class 100-250.

Nominal Size (Inches)	Actual O.D. (Inches)
4	4.80 to 5.00
6	6.90 to 7.10
8	9.05 to 9.30
10	11.10 to 11.40
12	13.20 to 13.50
14	15.30 to 15.70
16	17.40 to 17.80
18	19.50 to 19.90
20	21.60 to 22.1
24	25.80 to 26.30
30	31.70 to 32.70
36	38.00 to 39.20
42	44.20 to 45.60
48	50.50 to 52.00
54	56.70 to 58.40
60	62.80 to 64.80
72	75.30 to 76.90
84	87.50 to 88.50

Other Standard Sections used for Fence Posts

Section	CADWELD Mold Code
1-1/2" square	PS15
2" square	PS20
2-1/2" square	PS25
3" square	PS30*
1.875 x 1.625 x .133 "H"	PH1
2.25 x 1.95 x .143 "H"	PH2

* For D or F mold price only

Technical Information

STANDARD STEEL WIRE GAGE

(WASHBURN MOEN GAGE) SOLID

Gage No.	Dia. Inches	Gage No.	Diameter Inches
7/0	.4900	6	.1920
6/0	.4615	7	.1770
5/0	.4305	8	.1620
4/0	.3938	9	.1483
3/0	.3625	10	.1350
2/0	.3310	11	.1205
1/0	.3065	12	.1055
1	.2830	13	.0915
2	.2625	14	.0800
3	.2437	15	.0720
4	.2253	16	.0625
5	.2070	17	.0540

STEEL PIPE SIZES

STANDARD WEIGHT
(SCHEDULE 40)

ASTM A53-90-B
ANSI/ASME B36.10M-1985

Nominal Size In	O.D. Inches	Wall Thickness Inches	CADWELD Mold Code
1	1.315	.133	1
1-1/4	1.660	.140	1.25
1-1/2	1.900	.145	1.50
2	2.375	.154	2
2-1/2	2.875	.203	2.50
3	3.500	.216	3
3-1/2	4.000	.226	3.50
4	4.500	.237	4
5	5.563	.258	5
6	6.625	.280	6
8	8.625	.322	8
10	10.750	.365	10